

单晶四栅60片 LN260(30)M-4 (270-285W)

单晶四栅60片 LN260(30)M-4 (270-285W)

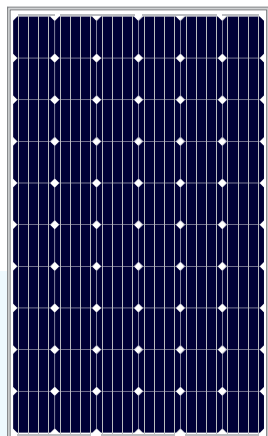

力诺组件优势

-  (0, +5W) 100%正公差
-  2次EL测试
-  25年不可撤销质量保险
-  5400帕雪压载荷, 2400帕风压载荷
-  低辐照度高性能保证
-  通过氨气测试和盐雾测试

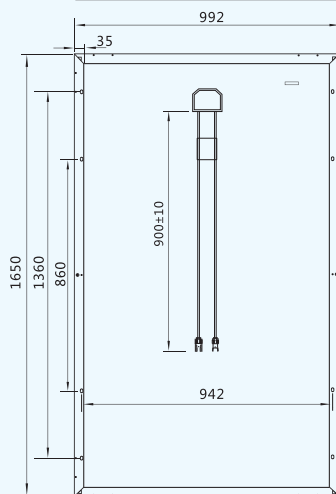
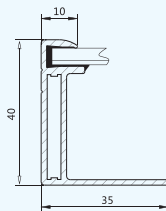
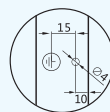
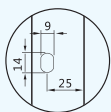
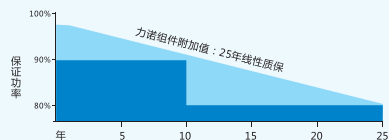

电性能参数

最大功率 (W)	最大工作电压 (V)	最大工作电流 (A)	开路电压 (V)	短路电流 (A)	填充因子	转化效率	最大系统电压	保险丝最大熔断值
270	31.47	8.58	38.18	9.20	76.87%	16.60%	1000V	15A
275	31.80	8.65	38.51	9.28	76.97%	16.90%	1000V	15A
280	32.04	8.74	38.77	9.37	77.08%	17.21%	1000V	15A
285	32.25	8.84	38.98	9.46	77.23%	17.52%	1000V	15A

额定温度参数

温度范围:	-40°C ~ +85°C
电池片额定工作温度:	46±2°C
短路电流温度系数:	0.049%/°C
开路电压温度系数:	-0.329%/°C
最大功率温度系数:	-0.439%/°C

机械性能参数

组件尺寸:	1650×992×40mm
组件重量:	19kg
雪载/风载:	5400/2400Pa
电池片数量:	60片
玻璃厚度:	3.2mm

质量保证

10年工艺技术, 材料质量保证。
25年性能保证: 10年保证组件90%功率输出;
25年保证组件80%功率输出。

包装信息

每托组件数量:	26片
平板车组件数量:	728片

270W 单晶组件I-V曲线图

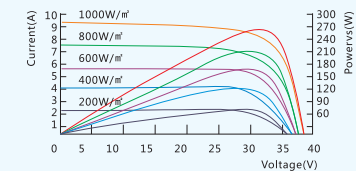
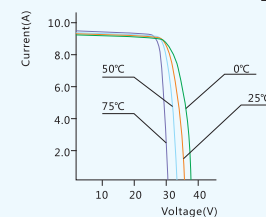

STC:  辐照度 1000W/m²
NOCT:  辐照度 800W/m²

 温度25°C
 温度20°C

 AM=1.5
 风速1米/秒